

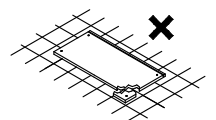

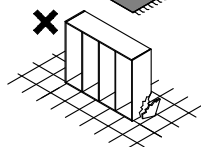

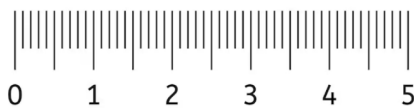

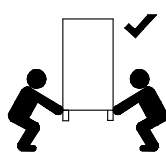
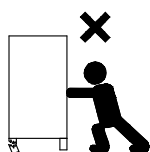
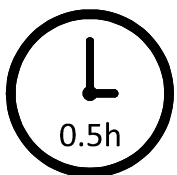
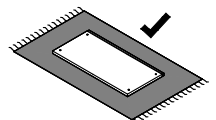
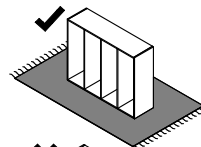
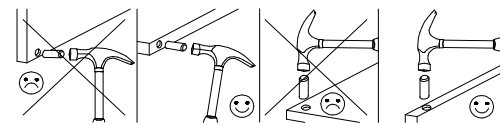
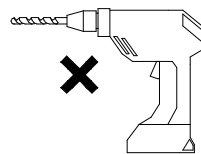
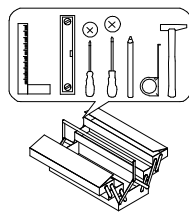
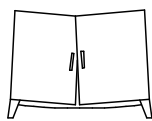
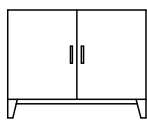
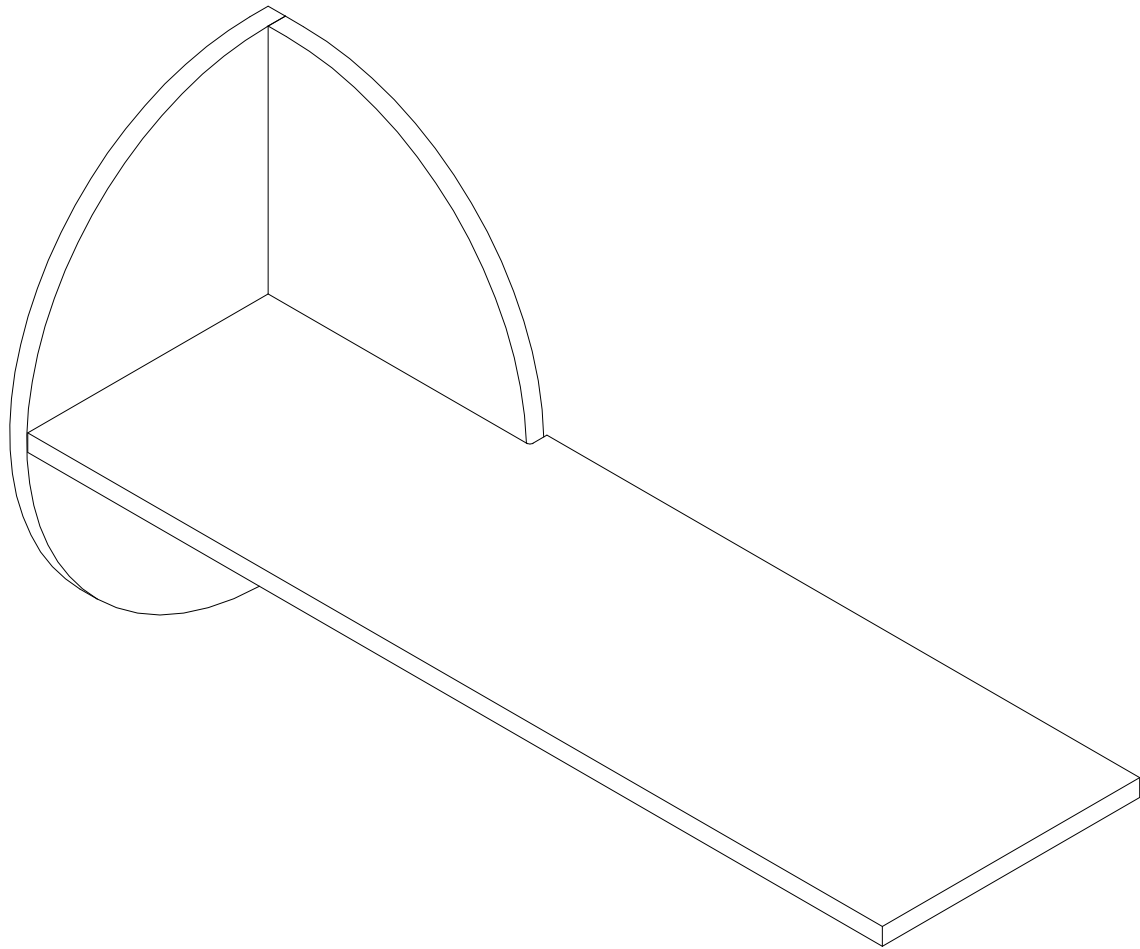
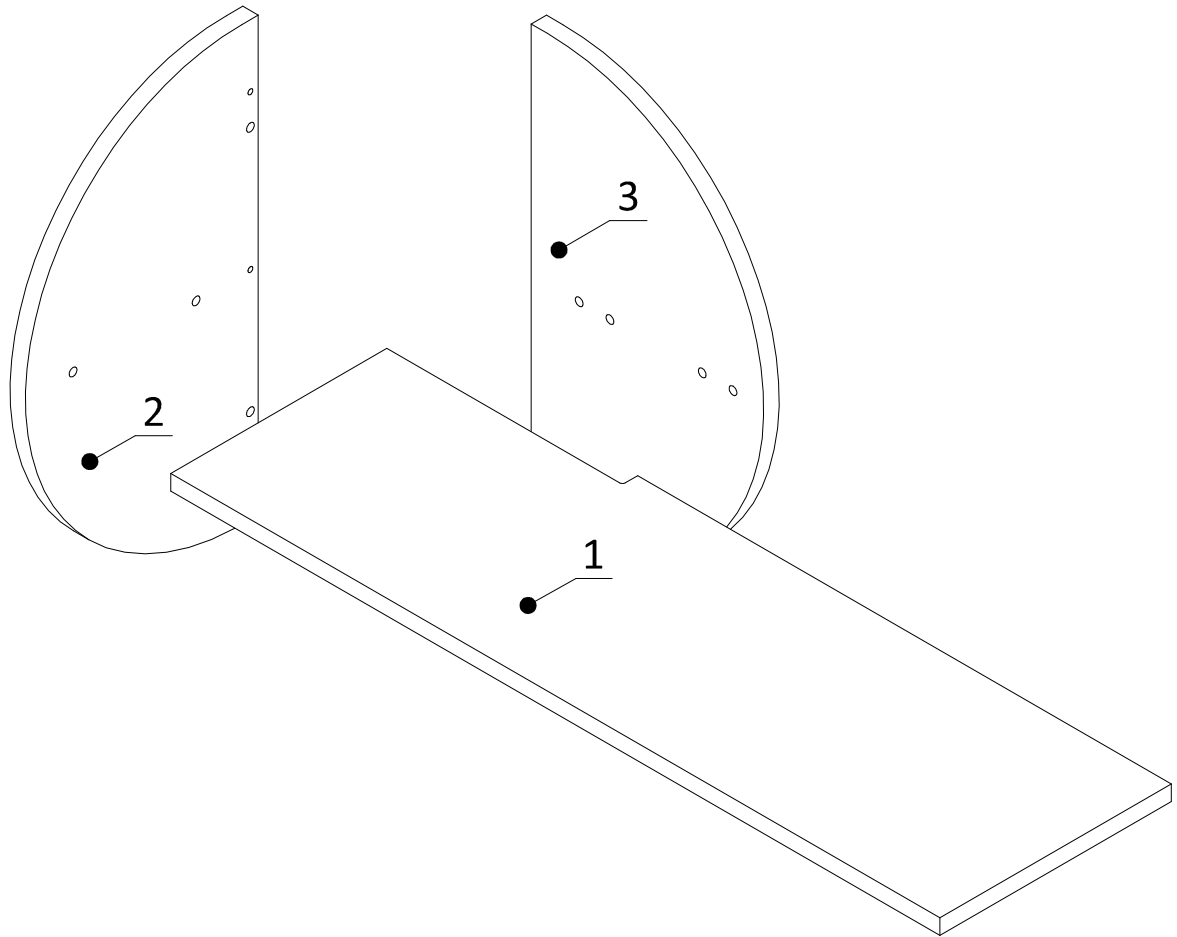
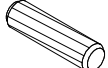

LEXI R-17

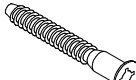

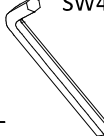

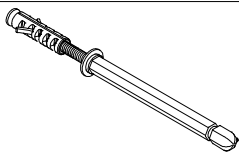

 <p>8x30</p>	 <p>15/12</p>	 <p>L20,3</p>	 <p>7x50</p>	 <p>6,3x9</p>	 <p>SW4</p>	 <p>ZW</p>	
K	M	T	KF	E2	KL	ZW	R
6x	3x	3x	2x	2x	1x	1x	1x

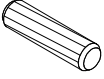
1

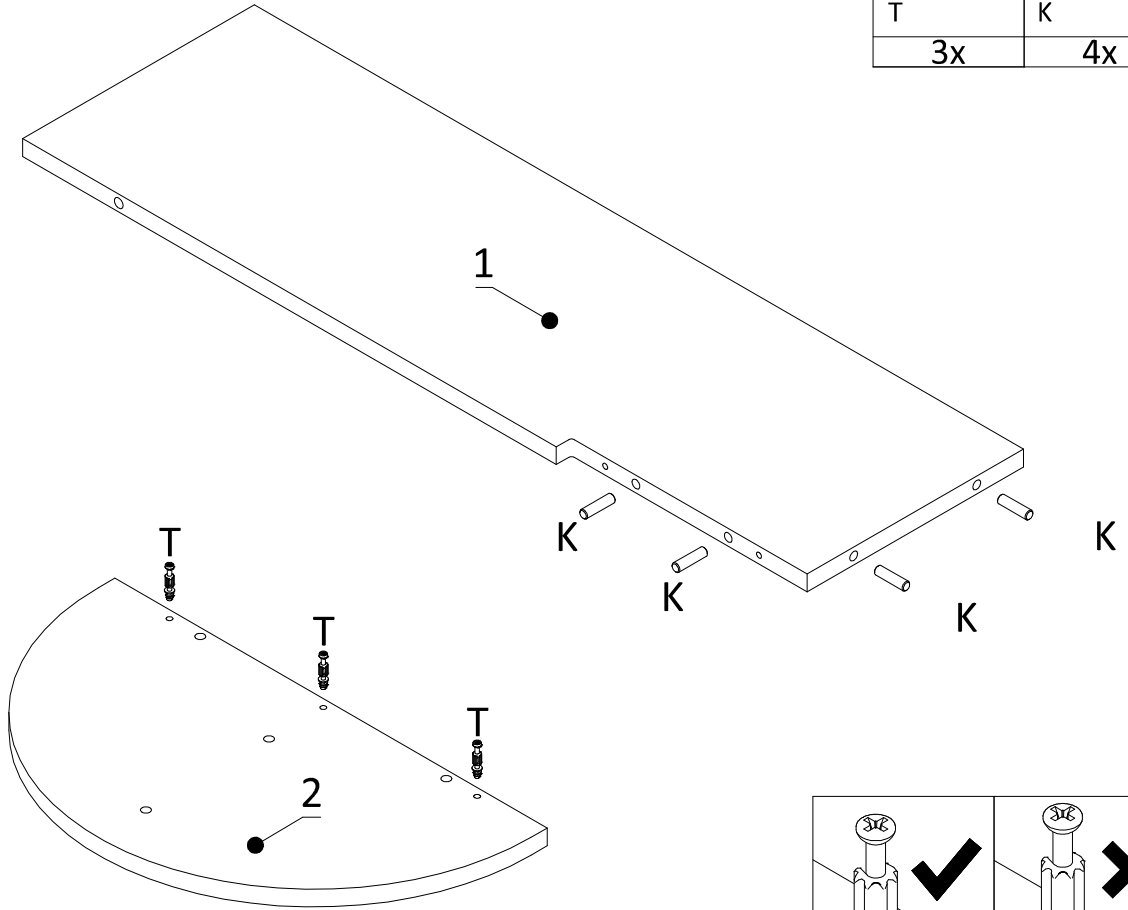
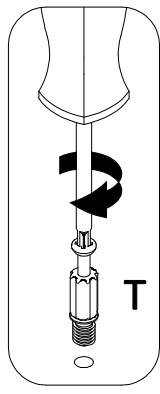
	
T	K
3x	4x

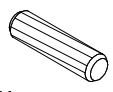

2

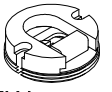
			
K	M	E2	ZW
2x	3x	2x	1x

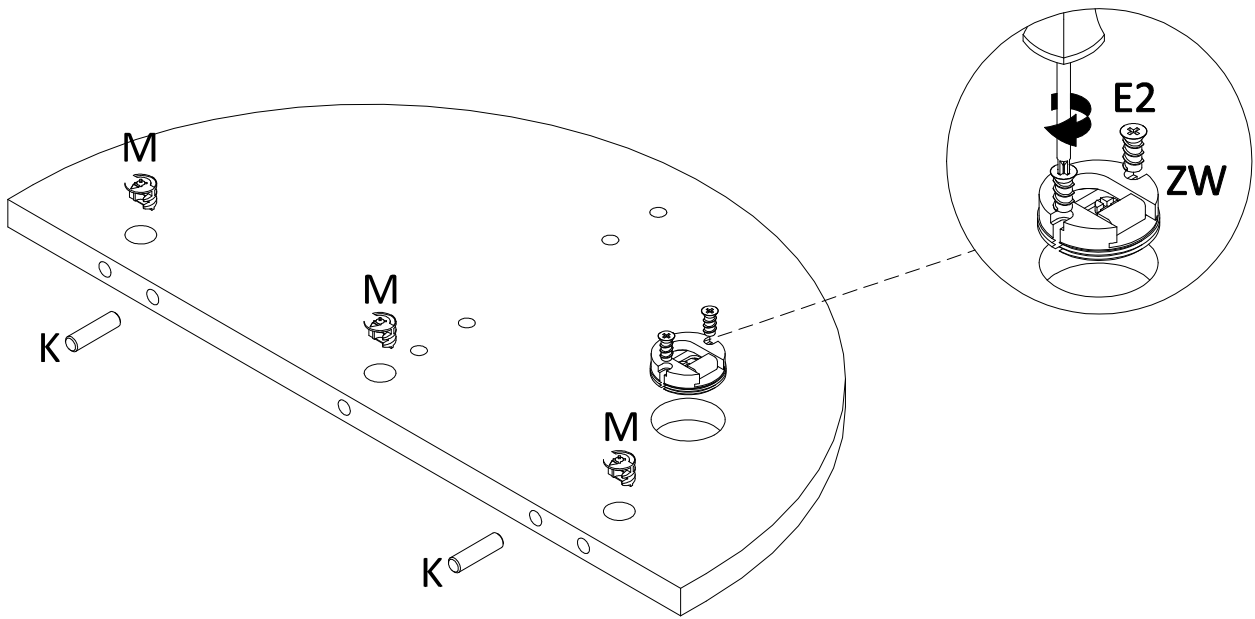

3

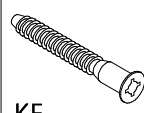
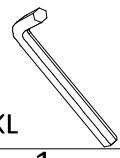
	
KF	KL
2x	1x

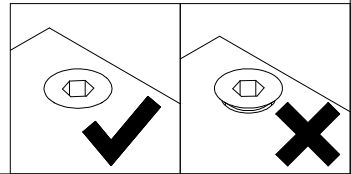
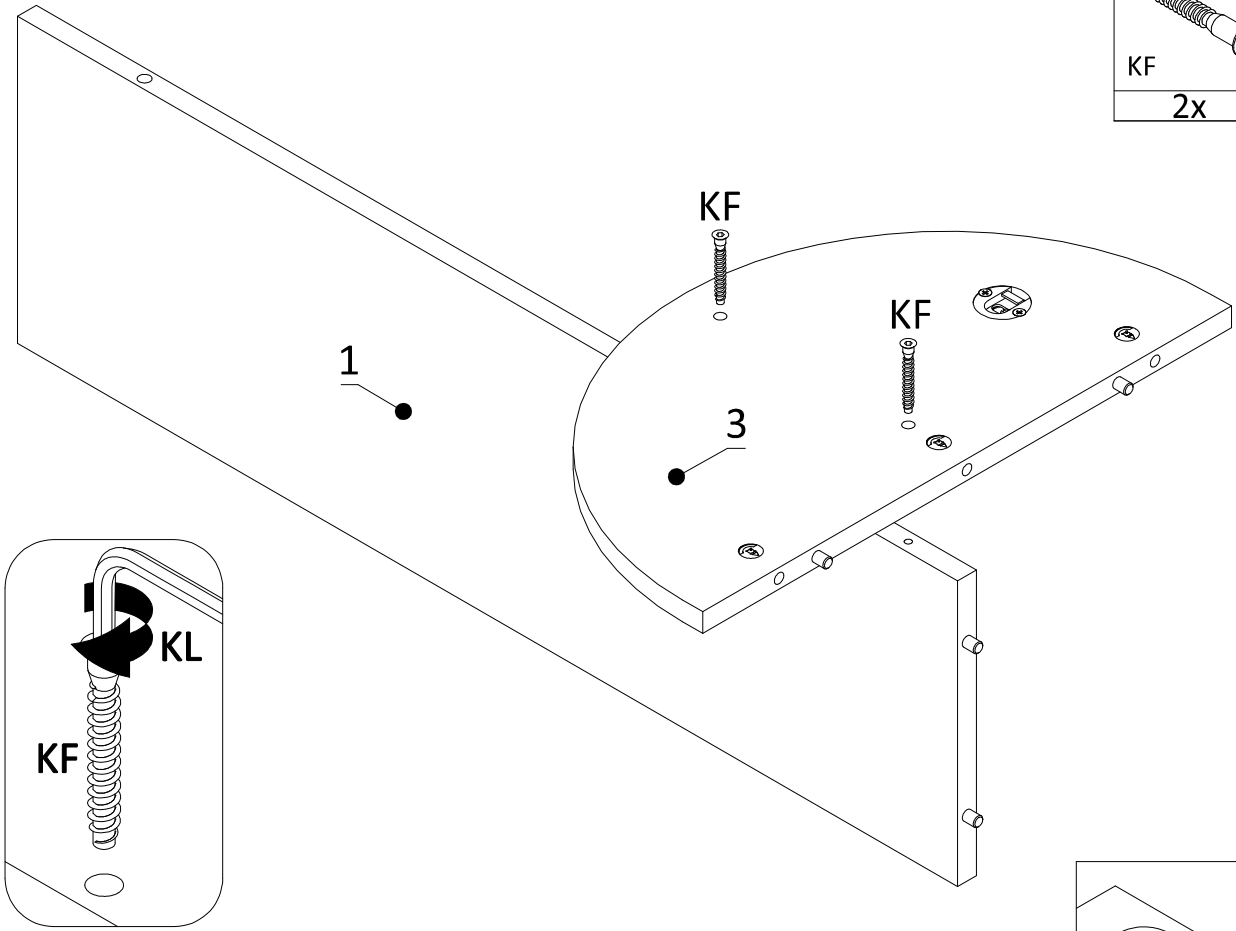

4

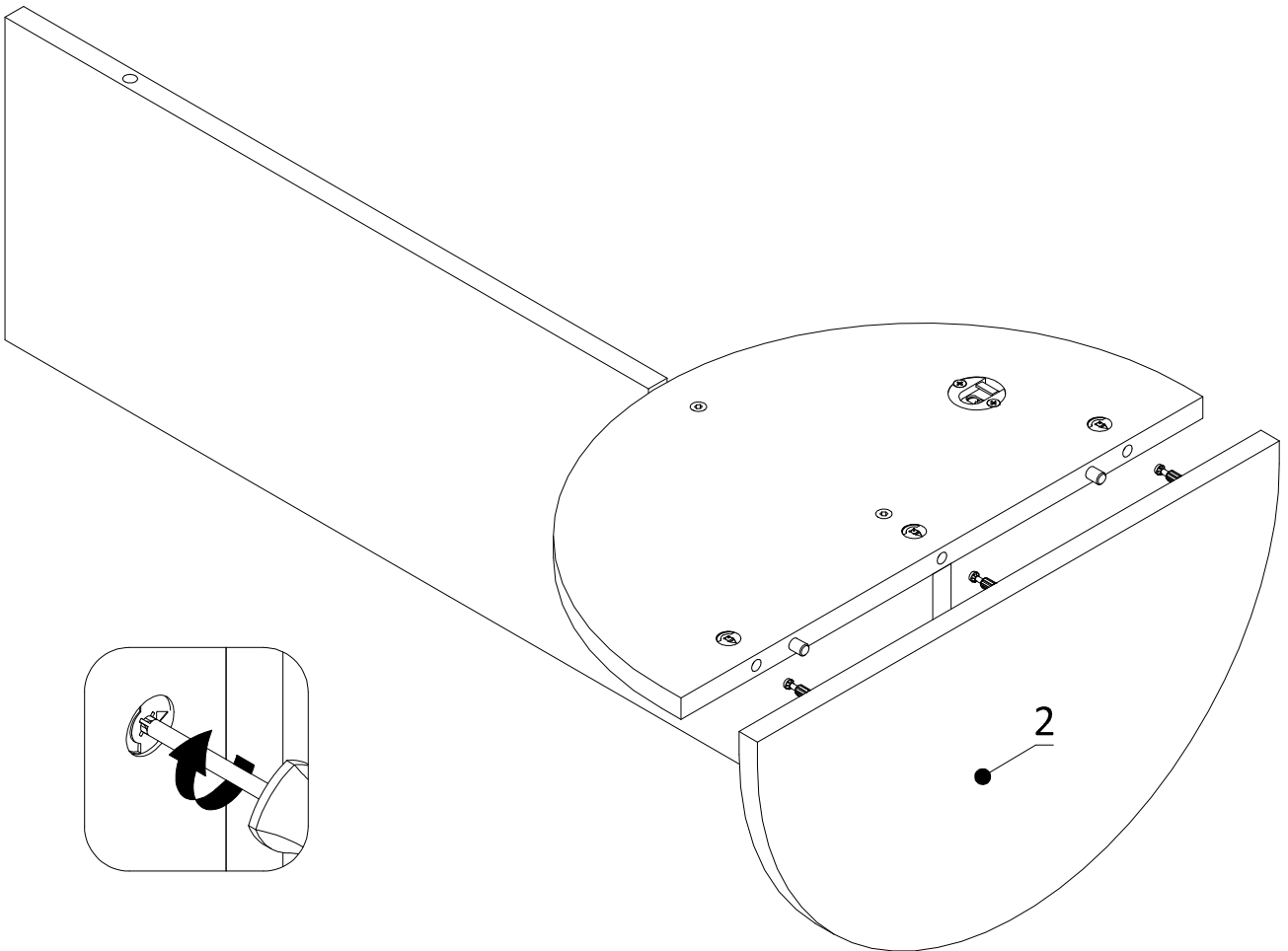

5

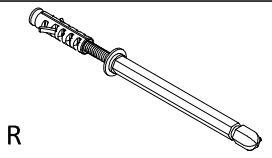
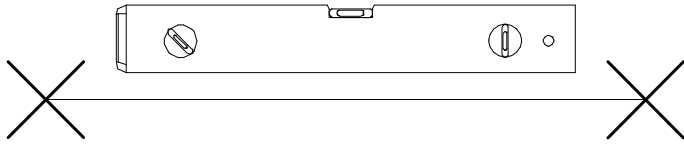

1x

